

Code:

ABSCON-35X1.25

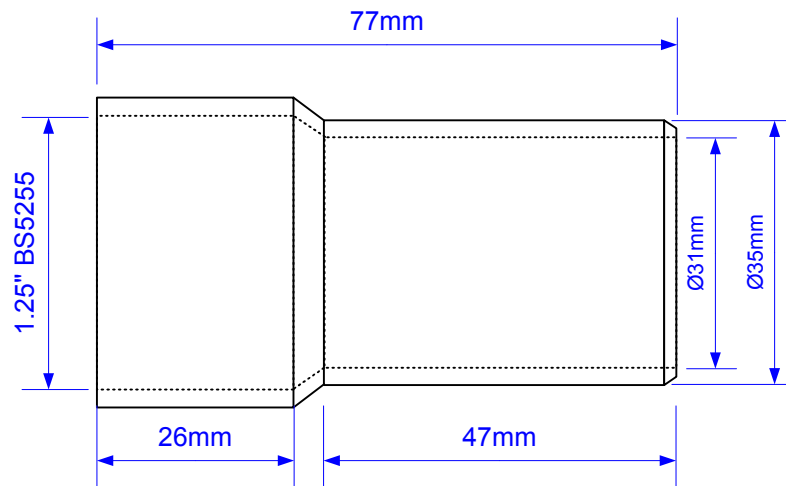

Drawing verified 09/12/2010
correct as of: RM

DRAWN BY
RM

REVISED

SCALE
1: 1

FILENAME
ABSCON-35X1.25.VSD

DATE
09/12/2010